



AlRider Crash Bars for BMW R 1200 GSW (2014 and Newer) INSTALLATION INSTRUCTIONS

The most up to date instructions can be downloaded from the product page at altrider.com, under the instructions tab.

Dear Rider,
Thank you for choosing AlRider! Whether a seasoned world adventurer or a first time ADV-Newbie, we welcome you to the AlRider experience. You can install your new product with the utmost confidence. AlRider designs, tests, and manufactures all of its products here in the United States. We are proud to do what we do, and honored to present to you the product of our labors.

Enjoy it, show it off, and most of all, RIDE IT!

Venture On,
Jeremy LeBreton



**AlRider Crash Bars for
BMW R 1200 GSW**

Package Contents:
- Crash bars
- Hardware kit

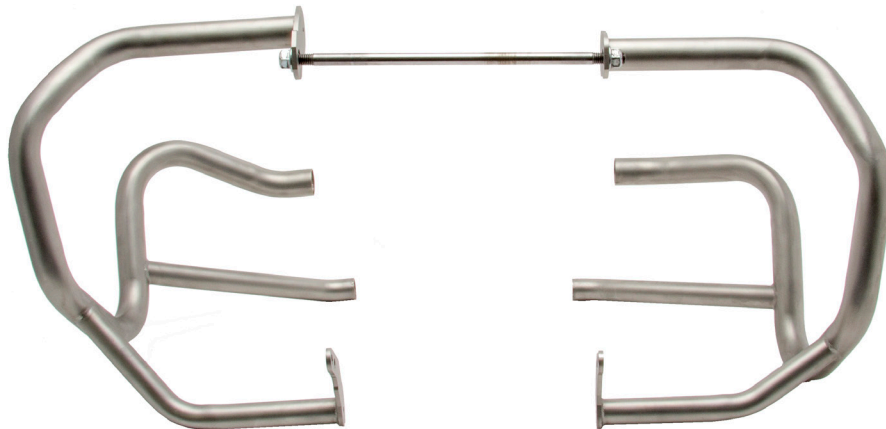

AlRider LLC

Global

mailing: 4000 Aurora Ave N Ste 100
Seattle, WA 98103 USA
phone: 206-922-3618
email: info@altrider.com
web: www.altrider.com

Europe

mailing: Oude Middenweg 231-M
2491 AG DEN HAAG
Netherlands
email: info@altrider.eu
web: www.altrider.eu

Rev 0
MADE IN THE USA



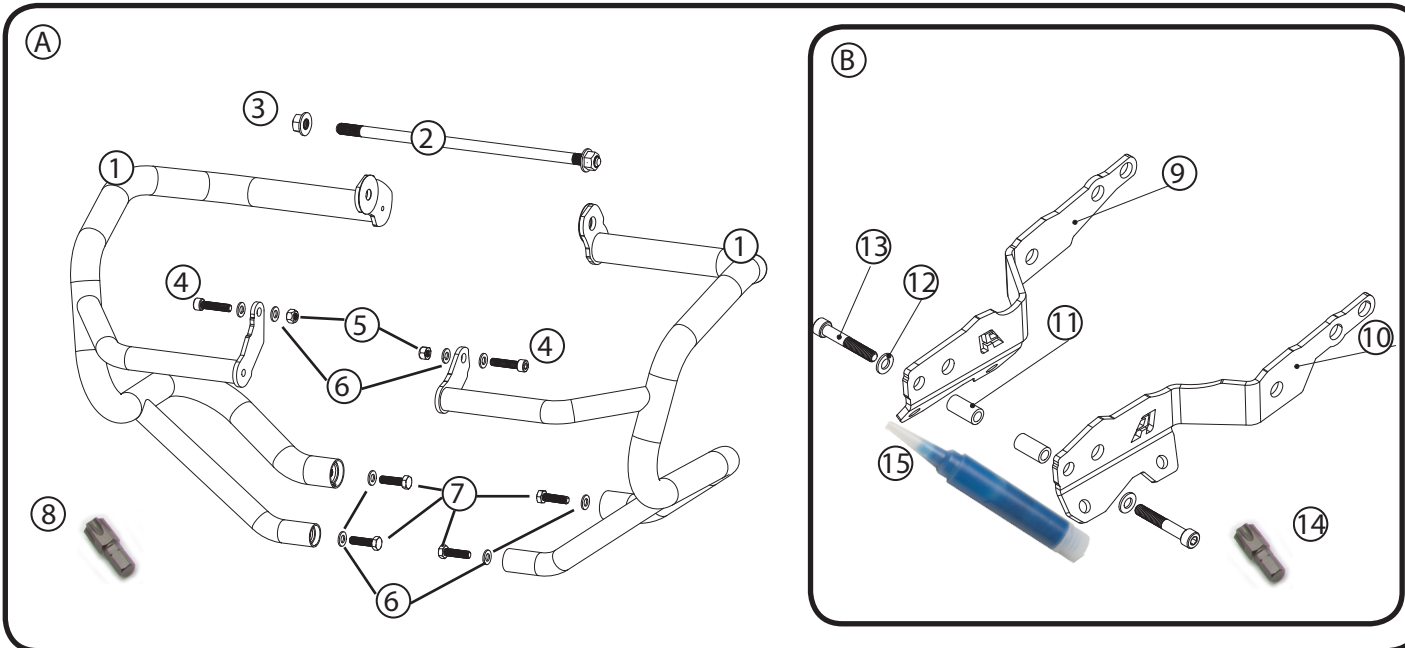

Kit:

- (A) Crash Bars Contents**
- ① Crash bars right and left side
 - ② Replacement engine bolt w/nut
 - ③ (1) M12 hex nut
 - ④ (2) M8 x 35mm SH screws
 - ⑤ (2) M8 lock nuts
 - ⑥ (8) M8 washers
 - ⑦ (4) M8 hex head bolts
 - ⑧ T55 Torx driver

(B) Bracket Contents

- ⑨ Right bracket
- ⑩ Left bracket
- ⑪ (2) Spacers
- ⑫ (2) M8 washers
- ⑬ (2) M8 x 50 SH cap bolts
- ⑭ T50 torx driver
- ⑮ Thread locker

Recommended tools:

- ① hardware tray
- ② 1/4" ratchet / 1/4" extension
- ③ 1/2" driver / 1/2" extension
- ④ 8mm socket
- ⑤ M6 allen
- ⑥ 13mm wrench (ratcheting preferred)
- ⑦ Thread locker
- ⑧ 18mm socket
- ⑨ torque wrench
- ⑩ 18 mm wrench (to hold engine bolt)



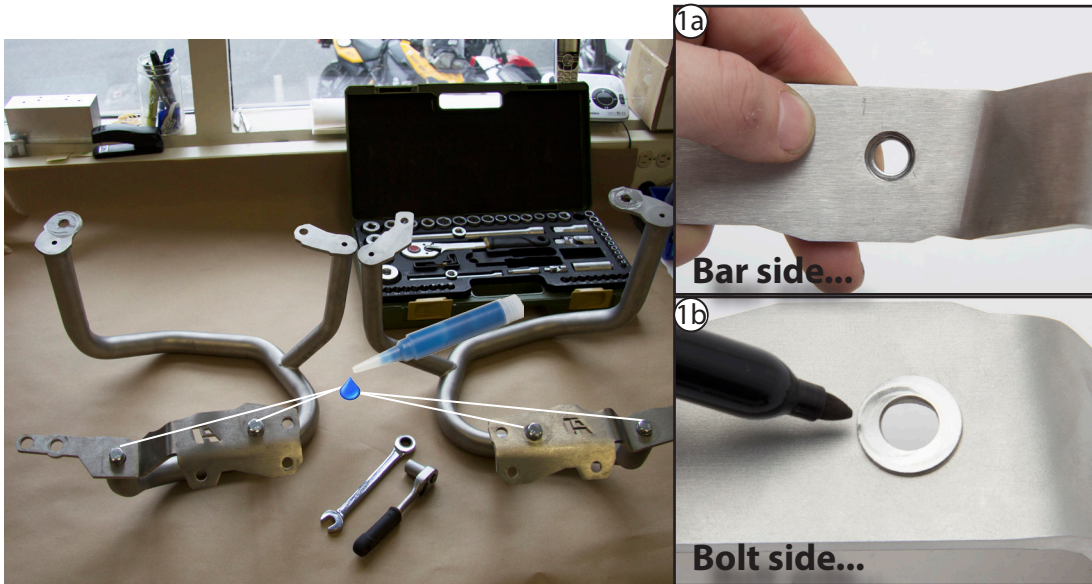

- ① Install brackets to their respective sides of crash bars using (4) M8 hex bolts, (4) M8 washers, and thread locker. Run the bolts all the way down but do not torque them, you want some play while completing the installation. **NOTE: If you plan to install the skid plate, DO NOT leave bolts loose for play. (see above) Use a sharpie and washer to find dead center and install brackets with dead center precision and ignore step 12. With outline of washer you can find dead center with bolts on. Torque these bolts to 25 nm.**

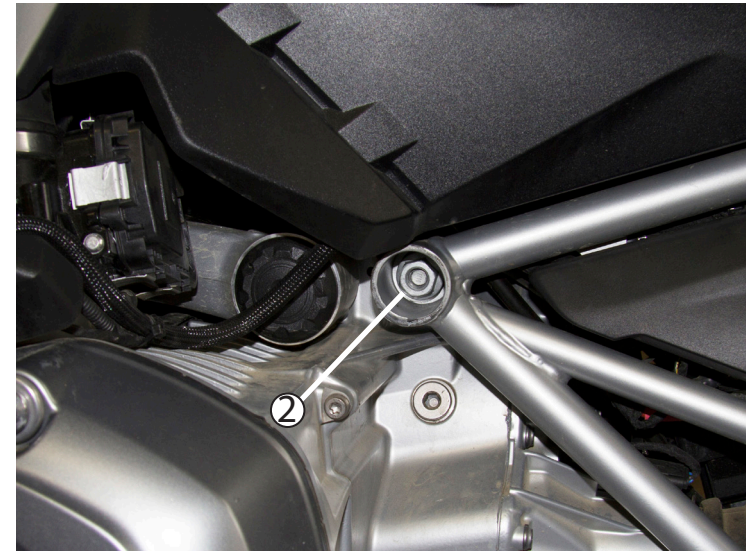

- ② With bike on center stand, remove OEM engine bolt using 18mm socket and T55 driver. Use a 1/4" extension to push the bolt out far enough that you can grab it and remove by hand.

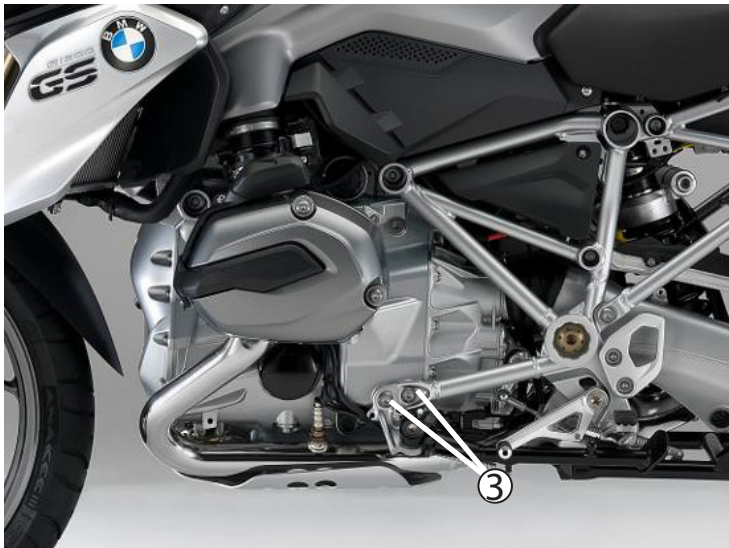

- ③ Using a T50 driver remove the (2) OEM M10 lower engine mount bolts on the left side.



- ④ Hang left side crash bars and insert engine bolt from the left side. Do not re-use spacers that come out with OEM bolt.

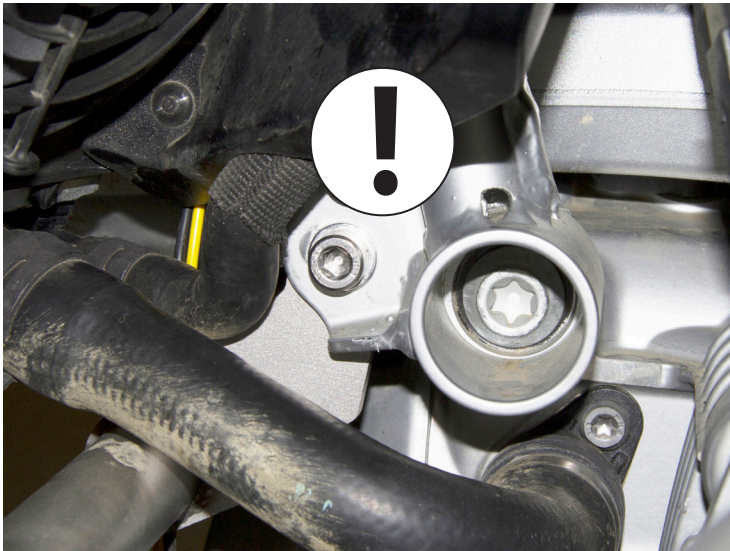

- ⑤ Install the (1) M8 bolt, (2) washers, and (1) lock nut to the top front mount using an M6 driver and 13mm wrench. The crash bar mount should be situated on the inside of the bike frame.

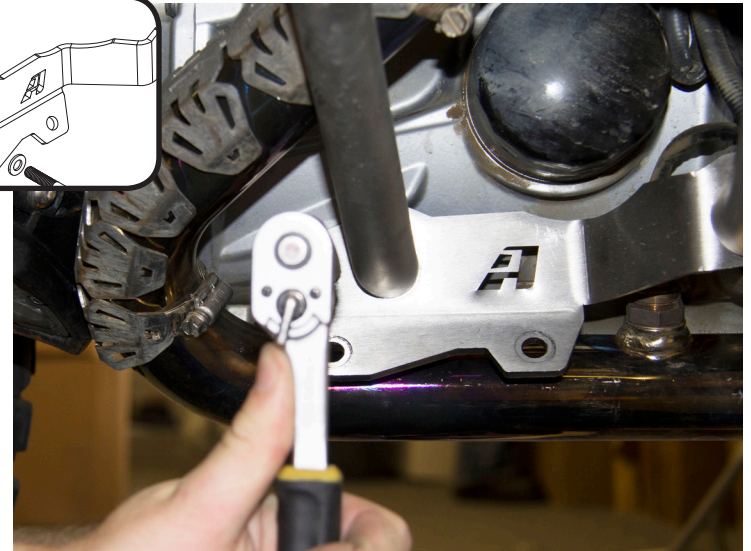
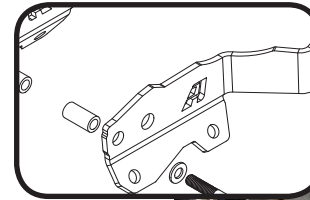

- ⑥ Install the M8 x 50mm bolt with washer, and spacer into the front mount position of the lower bracket. Use anti-seize. Do not torque all the way.

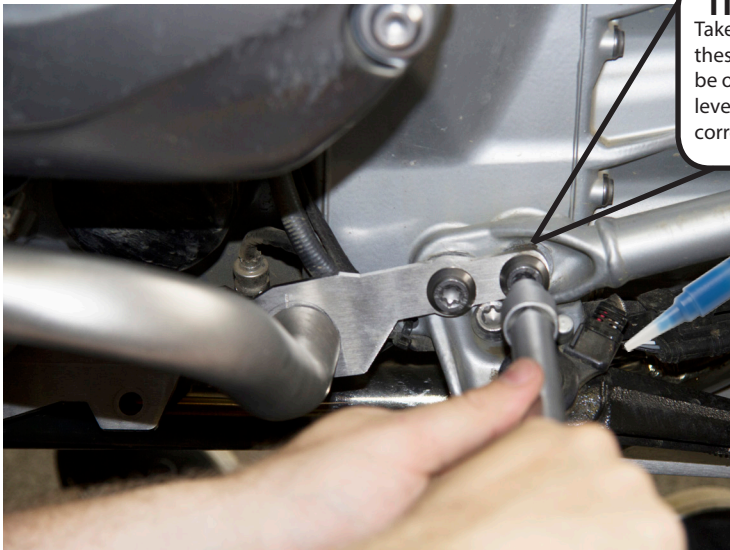
**TIP:**

Take caution when re-installing these bolts as the frame might be out of place. If necessary, leverage on the frame to get correct alignment.

- ⑦ Reinstall the (2) OEM M10 bolts using a T50 driver and clean bolt threads, chase threads in engine, apply thread locker, reinstall and do not tighten all the way. Go back to front and upper M8 bolts in step 5 and 6 and torque to 10 nm or torque. Return to the (2) OEM M10 bolts and torque to 55 nm or torque.



- ⑧ Remove the (2) OEM M10 bolts from frame spar (refer to step 3 for example image). Hang right side crash bars and begin to thread the 2nd M12 nut to hold bars hanging in place. NOTE: front upper mount should be positioned inside the frame.

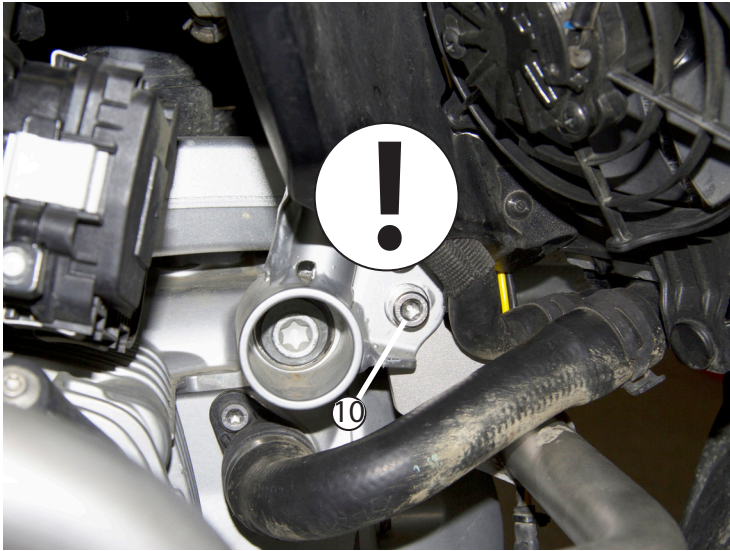

- ⑨ Install the (1) M8 bolt, (2) washers, and (1) lock nut to the top front mount using an M6 driver and 13mm wrench. The crash bar mount should be situated on the inside of the bike frame.

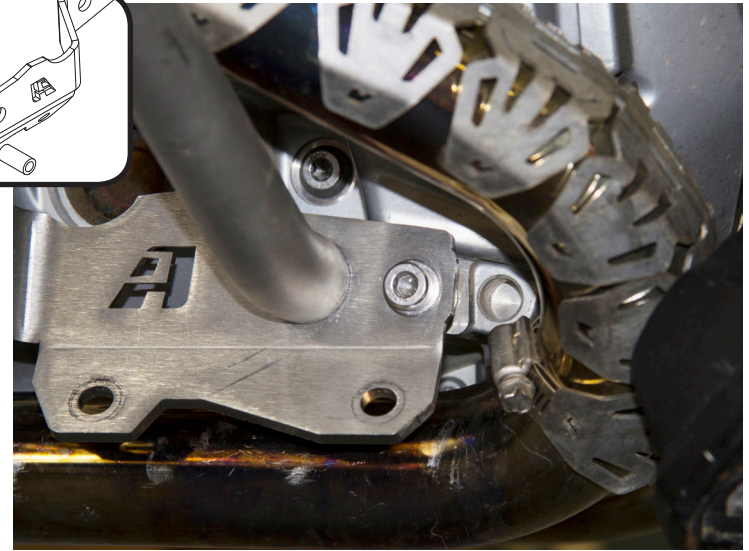
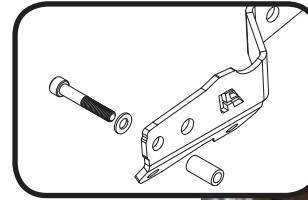

- ⑩ Install the M8 x 50 mm bolt with washer, and spacer into the front mount position of the lower bracket. Use anti-seize. Do not torque all the way.

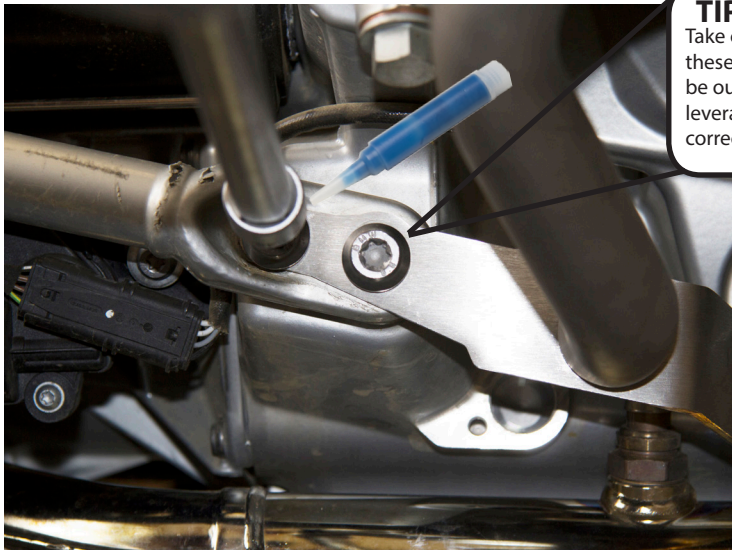

TIP:
Take caution when re-installing these bolts as the frame might be out of place. If necessary, leverage on the frame to get correct alignment.

- ⑪ Reinstall the (2) OEM M10 bolts using a T50 driver and clean bolt threads, chase threads in engine, apply thread locker, reinstall and do not tighten all the way. Go back to the front and upper M8 bolts in step 9 and 10 and torque to 10 nm or torque. Return to the (2) OEM M10 bolts and torque to 55 nm or torque.



- ⑫ Using a 13mm wrench, tighten all (4) M8 hex bolts holding bars to brackets on each side.

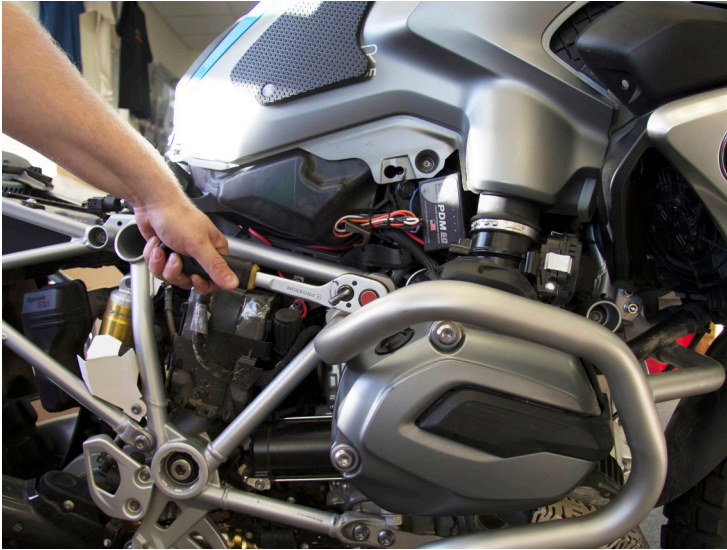

- ⑬ Using two 18 mm sockets, tighten the M12 engine bolt and then torque to 85 nm. Thread locker is not needed on this step because the nut is a locking type nut.



- ⑭ After riding for 100 - 500 miles check all fasteners to make sure they are at the correct torque setting.

CONGRATULATIONS!

You've completed your installation. If at any point you have questions about your installation or have any feed back for us, we'd love to hear it. A downloadable version of these instructions can be found at our web site. www.AltRider.com

After 5 hours of riding, or 100 miles, check all the fasteners on the assembly to ensure they are tightened to spec.

Global Office:

email: info@AltRider.com
phone: +1 206-922-3618
address: 4000 Aurora Ave N
Ste 100
Seattle, WA 98103

Europe Office:

email: info@AltRider.eu
address: Oude Middenweg 231-M
2491 AG DEN HAAG
Netherlands

TERMS OF USE, WARRANTY AND LIABILITY WAIVER

AltRider LLC, a Washington company, having its principal place of business in Seattle, WA ("AltRider") offers its motorcycle accessories (the "Product") with the terms, conditions and notices as follows:

Terms of Use

This Product is offered to you conditioned upon your acceptance without modification of the terms, conditions, and notices contained herein. Installation and/or use of this product implies acceptance of all such terms, conditions, and notices. If you do not agree to these terms, do not buy the Product. If you have already bought the Product and do not agree to these terms, return this Product promptly including the packaging and all written materials, to AltRider.

Limitation of Liability and Warranty Disclaimer

You may return your merchandise for a full refund or exchange, less any original or return shipping fees under these conditions:

1. Only if the merchandise is in 100% factory condition. Original manufacturer's packaging and same condition as sold – original boxes, packaging material, instructions, documentation, parts, and attached tags.
2. Only unused, unscratched, uninstalled, undamaged merchandise will be accepted. Do not install equipment until you are sure you want to keep it. Package items carefully in protective materials before returning them. Never ship an item in its original manufacturers packaging – it will arrive damaged. Please use a postal box or other adequate packaging to ensure your return or exchange is not damaged on the way back to AltRider.com.

To read more about our exchanges and returns policy, on the web, navigate to <http://www.altrider.com/info/exchangesAndReturns>

Excepting the warranties stated in the preceding paragraph, AltRider hereby disclaims all other warranties and conditions with regard to the Product including all implied warranties and conditions of merchantability and fitness for a particular purpose. There are no warranties which extend beyond the description on the face hereof. AltRider does not warrant against damages or defects arising out of use or installation of the Product. Installation instructions are provided for your convenience. AltRider is not responsible for any damages arising out of the installation, improper or otherwise, of the Product. No warranty of any kind, expressed or implied, is made regarding the safety of this Product.

To the extent allowed by law, AltRider shall not be held liable for any direct, indirect, punitive, incidental, special or consequential damages arising out of, or connected with, the use or misuse of this Product. Buyer assumes all risks and liability arising from use of this Product.

Entire Agreement

This document states the entire obligation of AltRider with respect to the Product. If any part of this agreement is determined to be void, invalid, unenforceable or illegal, including, but not limited to the warranty disclaimers and liability limitations set forth above, then the remainder of the agreement shall remain in full force and effect.

Applicable Law

This agreement is governed by the laws of Washington, USA. You hereby consent to the exclusive jurisdiction and venue of the courts of Washington, USA, in all disputes arising out of or relating to the use of this product.

